

*The most responsive
and dependable source
for quality.*

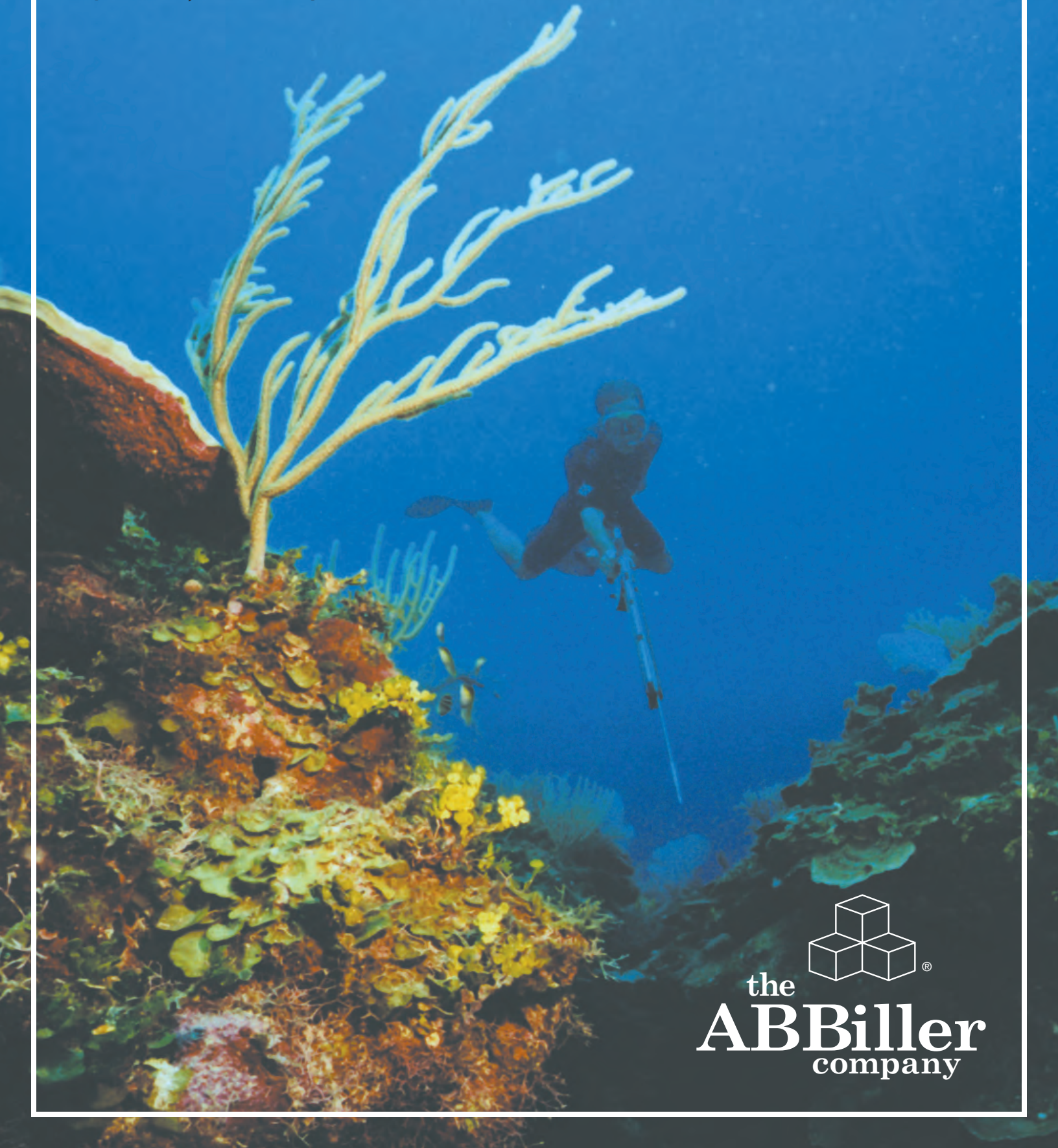

the
ABBiller
company

The A.B. Biller Speargun

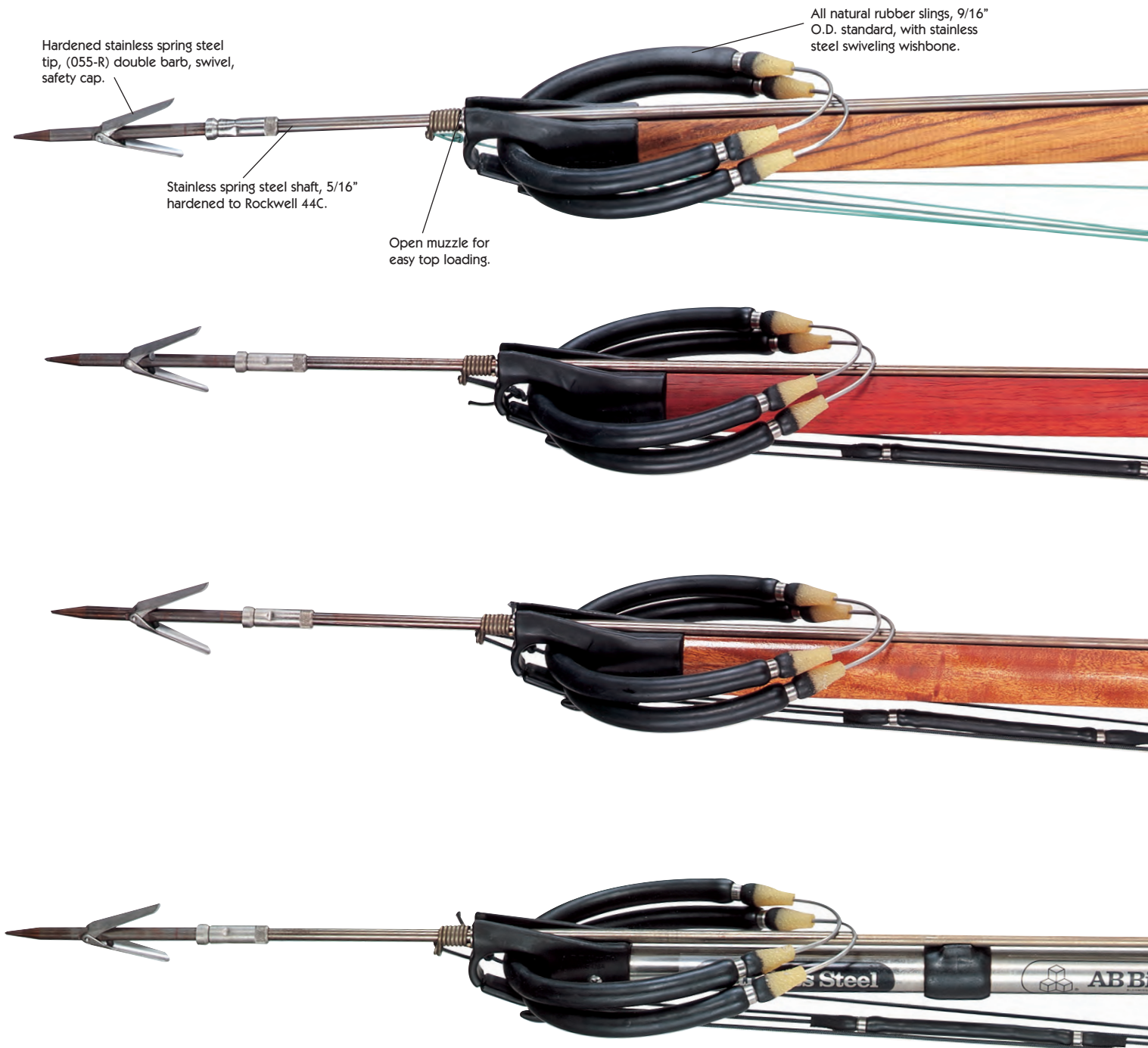

The A.B. Biller Speargun, built in the U.S.A. and in use all over the world, has proven itself as the foremost production speargun on today's market. The stainless steel trigger mechanism is unsurpassed in reliability and smooth action. The high grade grooved mahogany, teak, or padauk barrel provides pinpoint accuracy, easy underwater maneuverability due to its neutral buoyancy and absorbs 80% of the firing noise a metal gun will create. The importance of noise elimination when firing a speargun under water is a well known fact to most experienced and successful spearfisherman.

All A.B. Biller spearguns are provided with a stainless spring steel shaft 5/16" diameter, manufactured from a special alloy originally developed for the U.S. Navy. Heat treated to Rockwell 44C, these shafts produce a unique combination of hardness and spring tension. Two 9/16" O.D. natural rubber slings with special stainless steel swiveling wishbone and a hardened stainless spring steel double barb swivel tip are standard with A.B. Biller guns.

The A.B. Biller Company manufactures our spearguns in several variations and has provided the guns for many U.S. National and State Spearfishing Champions.

Redesigned and patented safety allows for easy, one-handed operation featuring silent lock and unlock. Adapts for both right- and left-handed position.

Improved and patented trigger mechanism manufactured from hardened stainless spring steel and housed in a Nylon cartridge provides smooth and reliable trigger action.

TEAK

Muzzle, grip and butt are rugged plastic.

The Biller Reel is a useful accessory designed to compliment our speargun line. It features a line lock and ambidextrous mounting.

PADAUK

MAHOGANY

36 Special AB Biller

STAINLESS STEEL

36 Professional

No matter how superior a speargun may be, the person using it remains the largest factor in safe and successful spearfishing. A weapon as it should be used with care, respect for the environment and with sportsmanship.

All A.B. Biller Spearguns come with three groove shafts for gun size 42" and longer.

The A.B. Biller Mahogany

Mahogany wood has a high strength factor compared to its weight and is very durable. It is widely used in marine applications.

All A.B. Biller spearguns are hand made. The mahogany wood receives 3 coats of polyurethane to protect it from environmental influences.



The A.B. Biller Mahogany is available in 7 sizes.

The Biller Reel



The Biller Reel is a useful accessory to all A.B. Biller spearguns, wood or metal style. Made of rugged plastic, it features a line lock and ambidextrous mounting.

BR-W Reel with Mounting Kit for all Wood Guns

Model #	Shaft Length	Gun Length, Muzzle to Butt
SM 60	60"	60"
SM 54	54"	55"
SM 48	48"	50"
SM 42	42"	45"
SM 36	36"	40"
SM 32	30"	35"
SM 24 Snubnose	24"	30"

The A.B. Biller Padauk

African Padauk (pronounced paduke, with the accent on the second syllable), is characterized by swirly, interlocking grain. It is almost entirely red in color and is easily one of the truly beautiful woods of the world.

The A.B. Biller Padauk spearguns are hand made and hand-rubbed with boiled linseed oil.

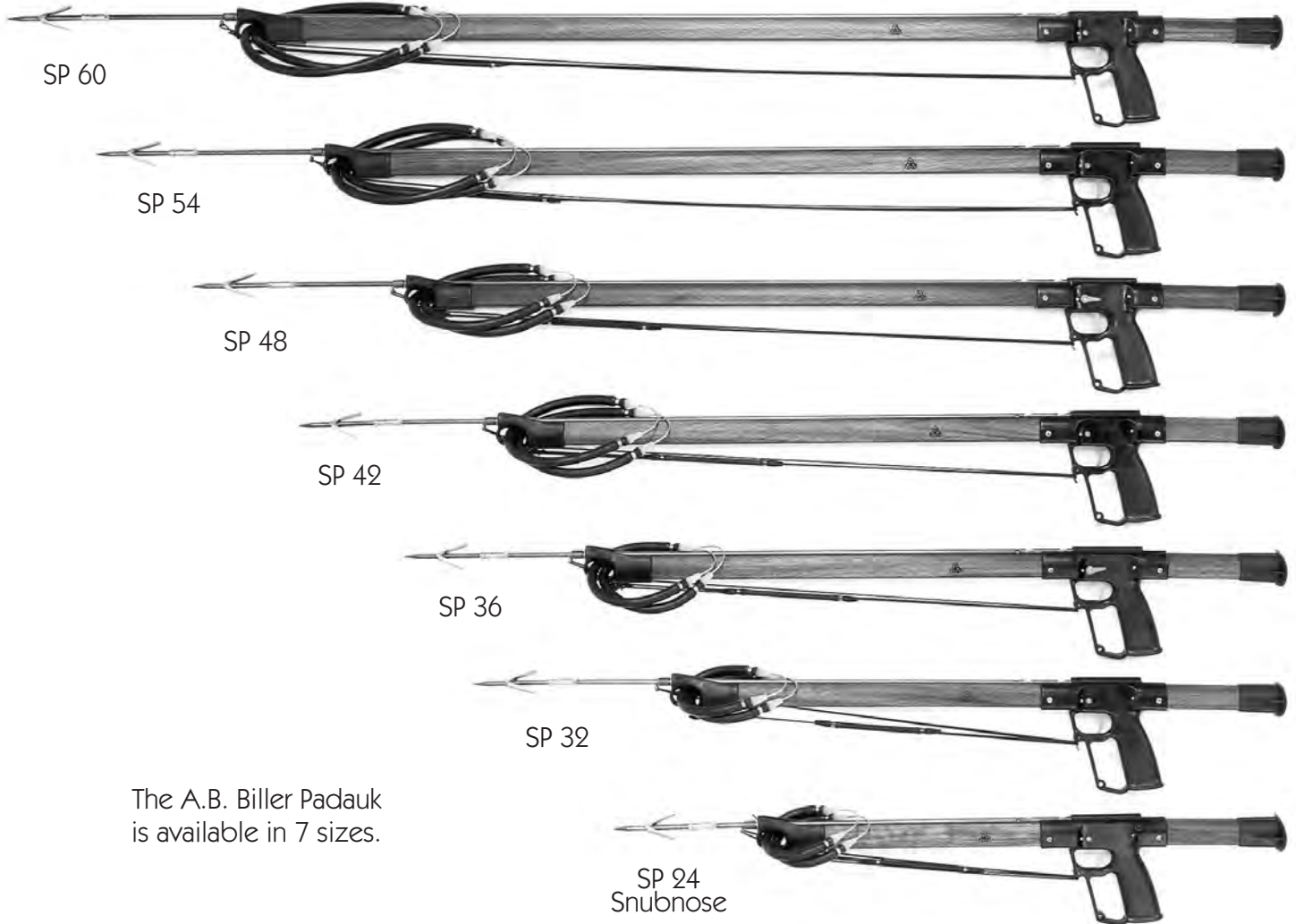

The A.B. Biller Padauk is available in 7 sizes.



Model #	Shaft Length	Gun Length, Muzzle to Butt
SP 60	60"	60"
SP 54	54"	55"
SP 48	48"	50"
SP 42	42"	45"
SP 36	36"	40"
SP 32	30"	35"
SP 24 Snubnose	24"	30"

The A.B. Biller Teak

Teak is one of the most valuable of all woods, but its use is limited by scarcity and high cost. Due to the heavy silicate content, it does not cause corrosion when placed next to metal, hence it is extremely useful in the building of ships. No satisfactory substitute has ever been found for Teak in this work.

The A.B. Biller Teak speargun is as beautiful as it is functional. Barrel and butt piece are carefully cut from the same piece of wood grain. The wood is hand-rubbed with boiled linseed oil.

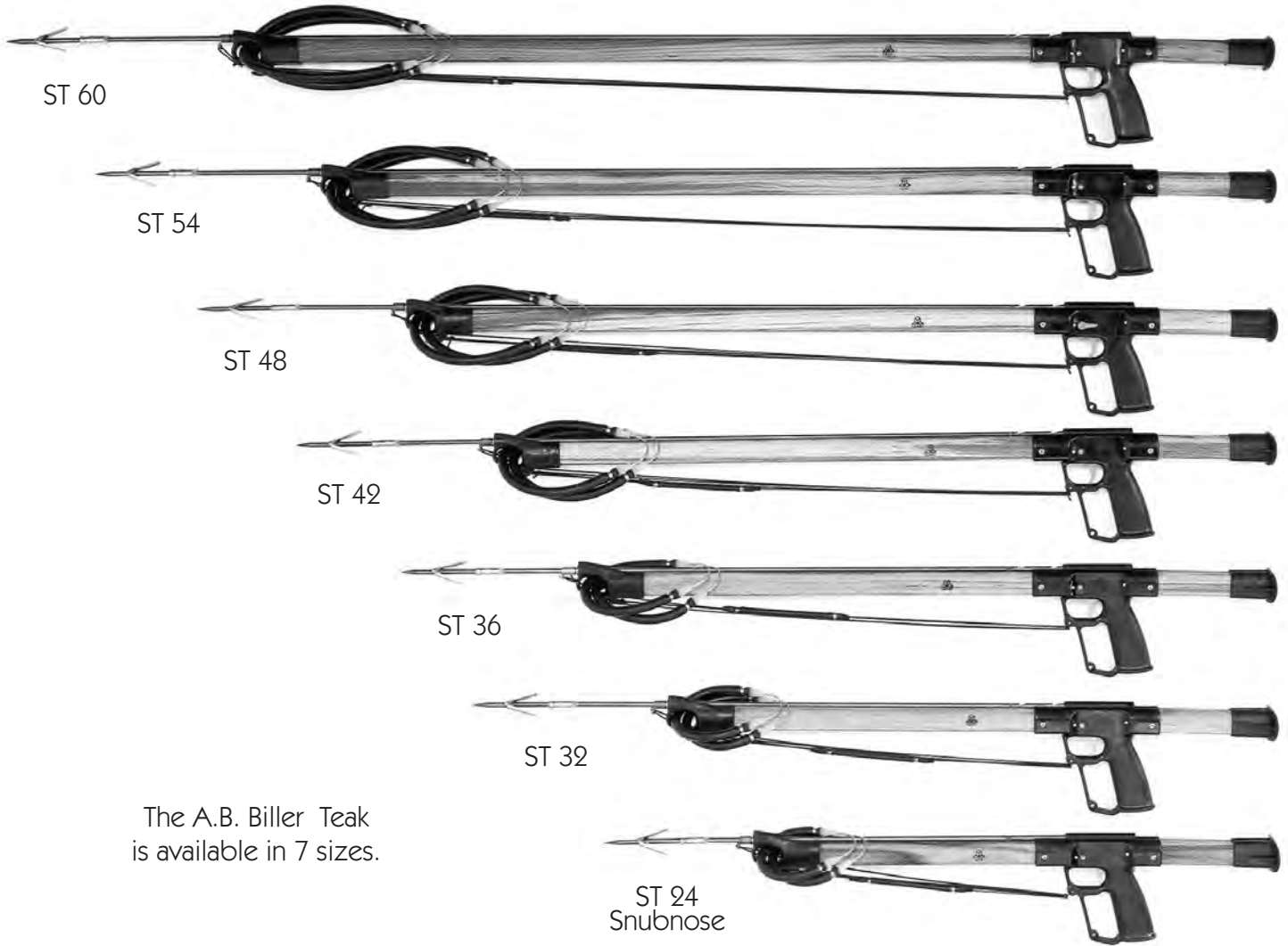

The A.B. Biller Teak is available in 7 sizes.

Model #	Shaft Length	Gun Length, Muzzle to Butt
ST 60	60"	60"
ST 54	54"	55"
ST 48	48"	50"
ST 42	42"	45"
ST 36	36"	40"
ST 32	30"	35"
ST 24 Snubnose	24"	30"



The Stainless Steel Professional

In the making of A.B. Biller tubular spearguns, specially manufactured, sandblasted 1" diameter stainless steel is used exclusively. A unique sealplug prevents water seepage into the gun barrel and is guaranteed to withstand pressure to a 200' depth. One to three Nylon guide rings (depending on the length of the speargun) assures accurate and quiet projection of the shaft when released.

The stainless steel speargun is available with the same standard features as its wooden counterpart, including hardened stainless spring steel shaft; hardened stainless spring steel double barb, rockpoint, swivel tip; two 9/16" gun bands; and the redesigned grip and trigger mechanism, with a safety that can be installed to accommodate both right- and left-handed divers.

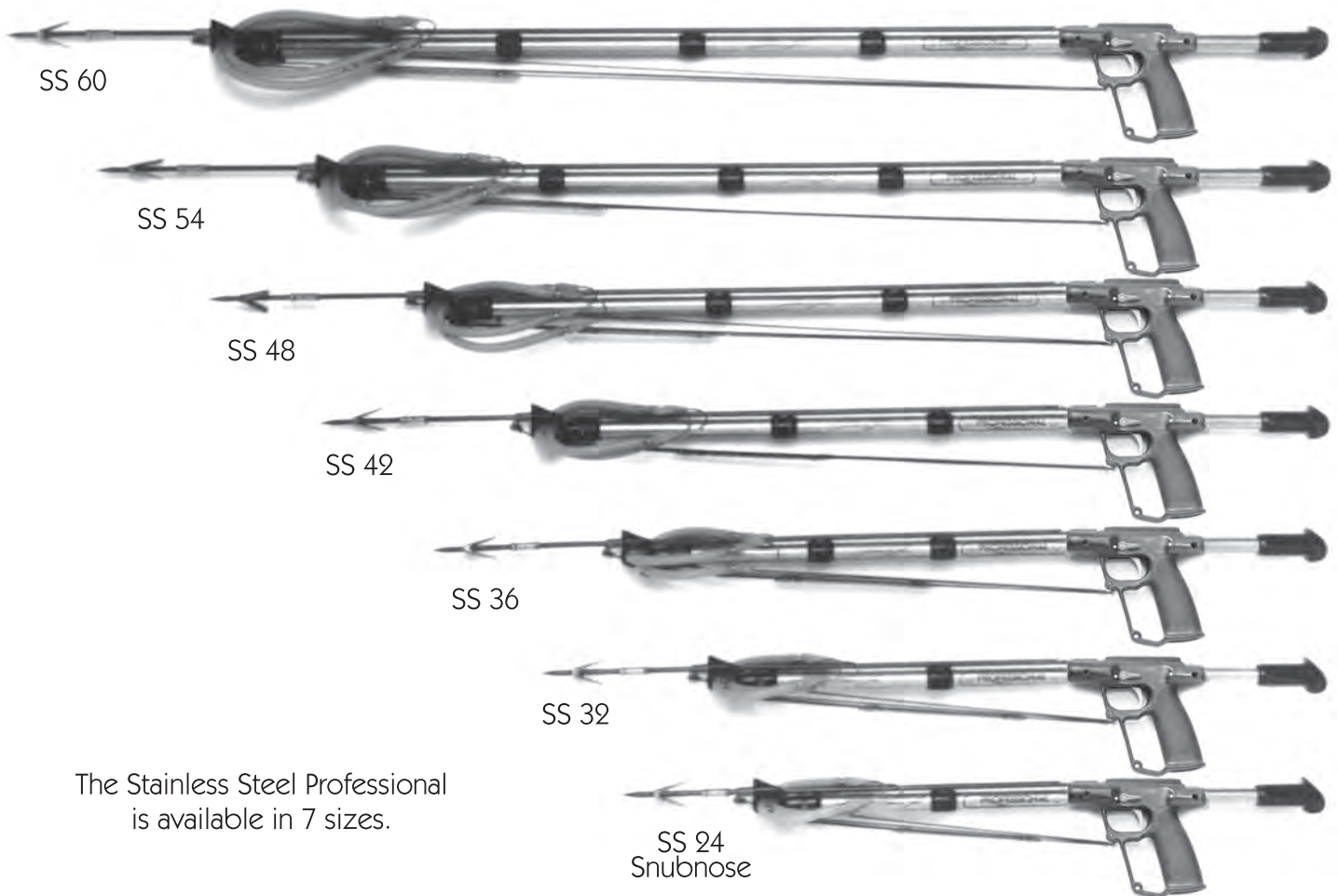

The Stainless Steel Professional is available in 7 sizes.

The Biller Reel

The Biller Reel is a useful accessory to all A.B. Biller spearguns, wood or metal style. Made of rugged plastic, it features a line lock and ambidextrous mounting.

BR-M Reel with Mounting Kit for Metal Gun



Model #	Shaft Length	Gun Length, Muzzle to Butt
SS 60	60"	60"
SS 54	54"	55"
SS 48	48"	50"
SS 42	42"	45"
SS 36	36"	40"
SS 32	30"	35"
SS 24 Snubnose	24"	30"

The A.B. Biller Floridian

The Floridian is a result of the partnership we maintain with our patrons, their experience, knowledge and their love for the sport of underwater hunting. Designed with the ever growing open water and deep water hunters in mind, we are introducing the "Floridian" and claim that it is the longest shooting, powerful, accurate, easy to use and most affordable speargun on the market today.

A 9/32" heat treated speed shaft provides power, accuracy and extended range. Two diametrically opposed barbs, directly mounted at the tip of the shaft, reduce drag by 40% and assure maximum speed and accurate long range shots. The 1000 lb. Kevlar® shock cord in combination with our hardened Compact Slide Ring is capable of holding even the largest food fish. A quick line disconnect makes removal of the shaft from the fish fast and easy.



SM 48-FL 48" Mahogany Floridian

SM 54-FL 54" Mahogany Floridian (not pictured)



SFS 54 54" Floridian shaft, 2 barbs, SLR-C, 3 grooves
SFS 60 60" Floridian shaft, 2 barbs, SLR-C, 3 grooves

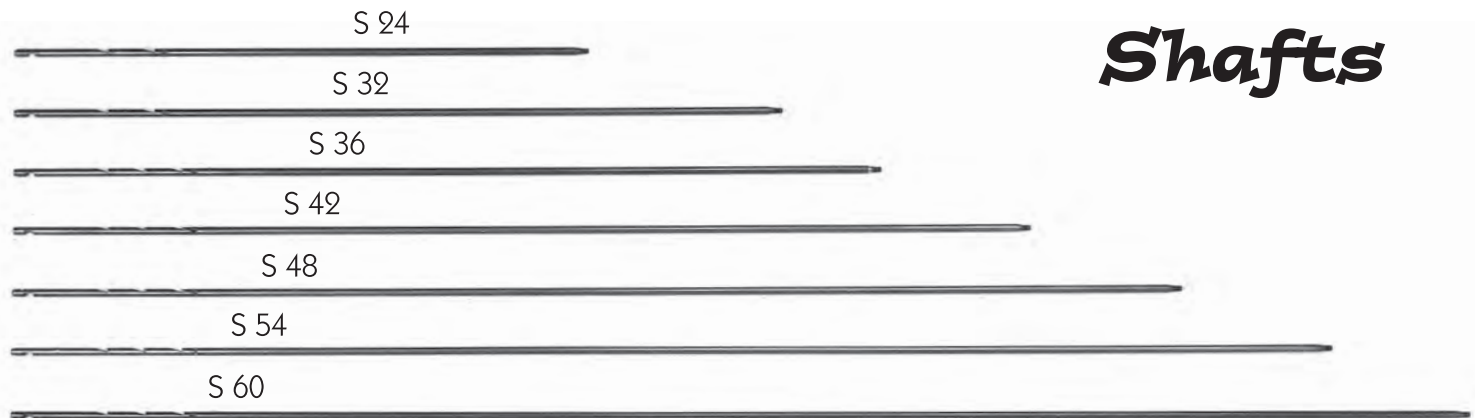

Shafts

All A.B. Biller shafts are stainless spring steel manufactured from a special alloy originally developed for the U.S. Navy. Heat treated to Rockwell 44C, these shafts produce a unique combination of hardness and spring tension.

Line shafts 42" and longer come with 3 grooves to accommodate 3 bands if desired.

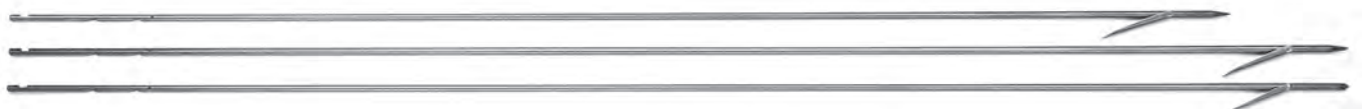

SF 54 54" fre shaft, Rockpoint
SF 60 60" fre shaft, Rockpoint

SF 60T 60" fre shaft, threaded 5/16" tip

For a detailed description of all available A.B. Biller shafts, please consult your A.B. Biller price list.

Gun Replacement Parts

For Wood Guns:

- B 10 Muzzle, wood gun
- B 40 Trigger mechanism
- B 20 Grip complete, wood gun
- B 30 Butt, wood gun
- B 29 Line Drop Assembly

For information about A.B. Biller Gun Bands and Shock Cords, see page 12-13.



B 40



B 10



B 30



B 20



B 29

For Metal Guns:

- B 11 Muzzle, metal gun
- B 88 Seal Plug
- B 89 Guide Ring
- B 24 Grip complete
- B 31 Butt, metal gun



SPR

SLR



SLR-C

- SPR Slide Spring
 - SLR Slide Ring
 - SLR-C Compact Slide Ring
- Avail. in 5/16" and 9/32"



B 89



B 88



B 24



B 24



B 31

Power Head & Spearshaft Holder

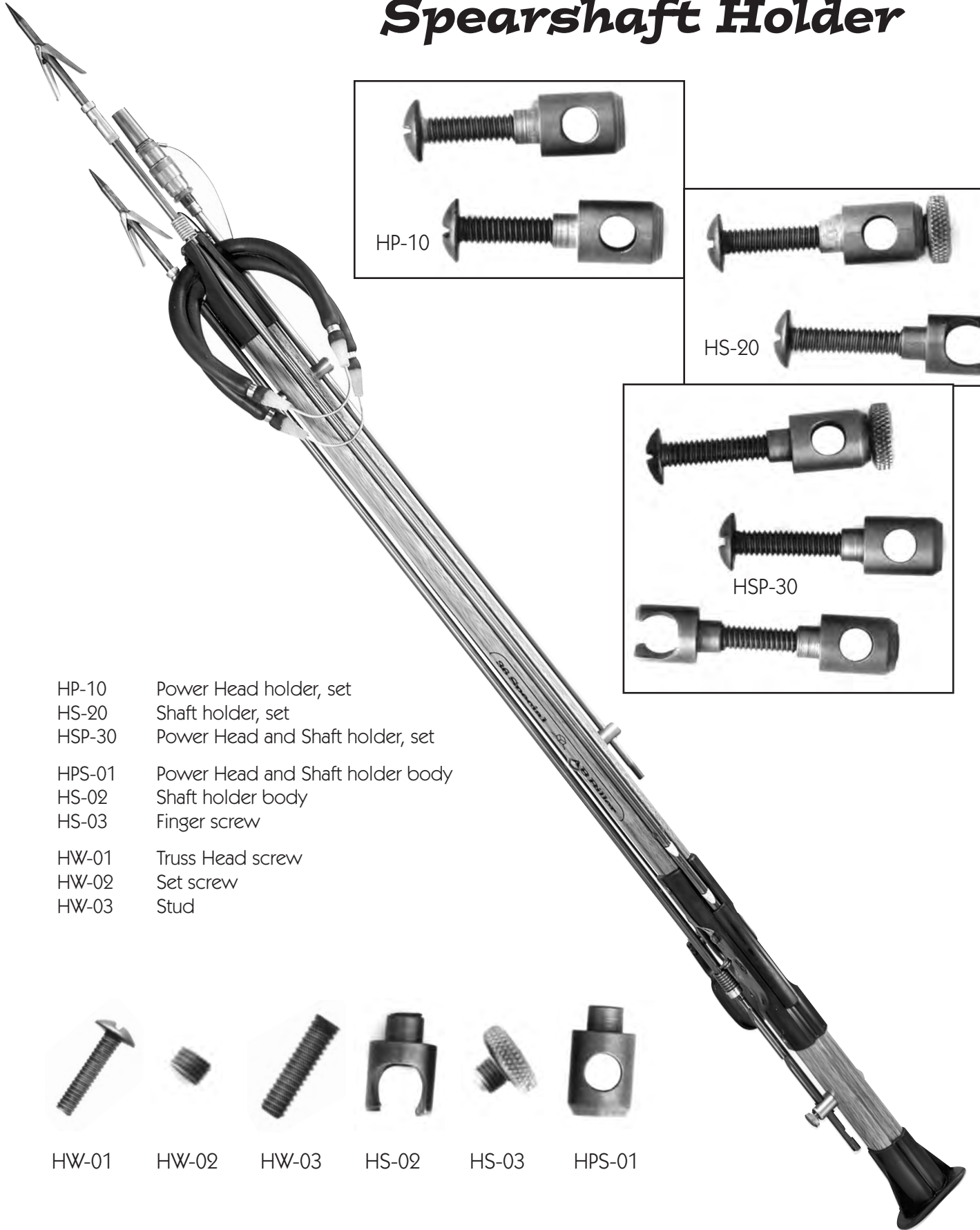

- HP-10 Power Head holder, set
- HS-20 Shaft holder, set
- HSP-30 Power Head and Shaft holder, set
- HPS-01 Power Head and Shaft holder body
- HS-02 Shaft holder body
- HS-03 Finger screw
- HW-01 Truss Head screw
- HW-02 Set screw
- HW-03 Stud



HW-01 HW-02 HW-03 HS-02 HS-03 HPS-01

Power Heads

These A.B. Biller designed and precision engineered Power Head units are the most advanced and reliable products of its kind available.

The .38, .357 as well as the .44 caliber Power Heads are manufactured of high grade stainless steel with newly designed firing mechanism and safety.

They have been designed and manufactured according to the regulations set forth under the NATIONAL FIREARMS ACT.

FEDERAL LAW REQUIRES that the firing pin be 26" long. Any Power Head (fish popper) NOT CONFORMING is considered CONTRABAND and subject to confiscation by the Bureau of Alcohol, Tobacco and Firearms, U.S. Treasury Department – BATF.

Mere possession can entail serious criminal penalties.

Available with 6 mm and 5/16" thread.

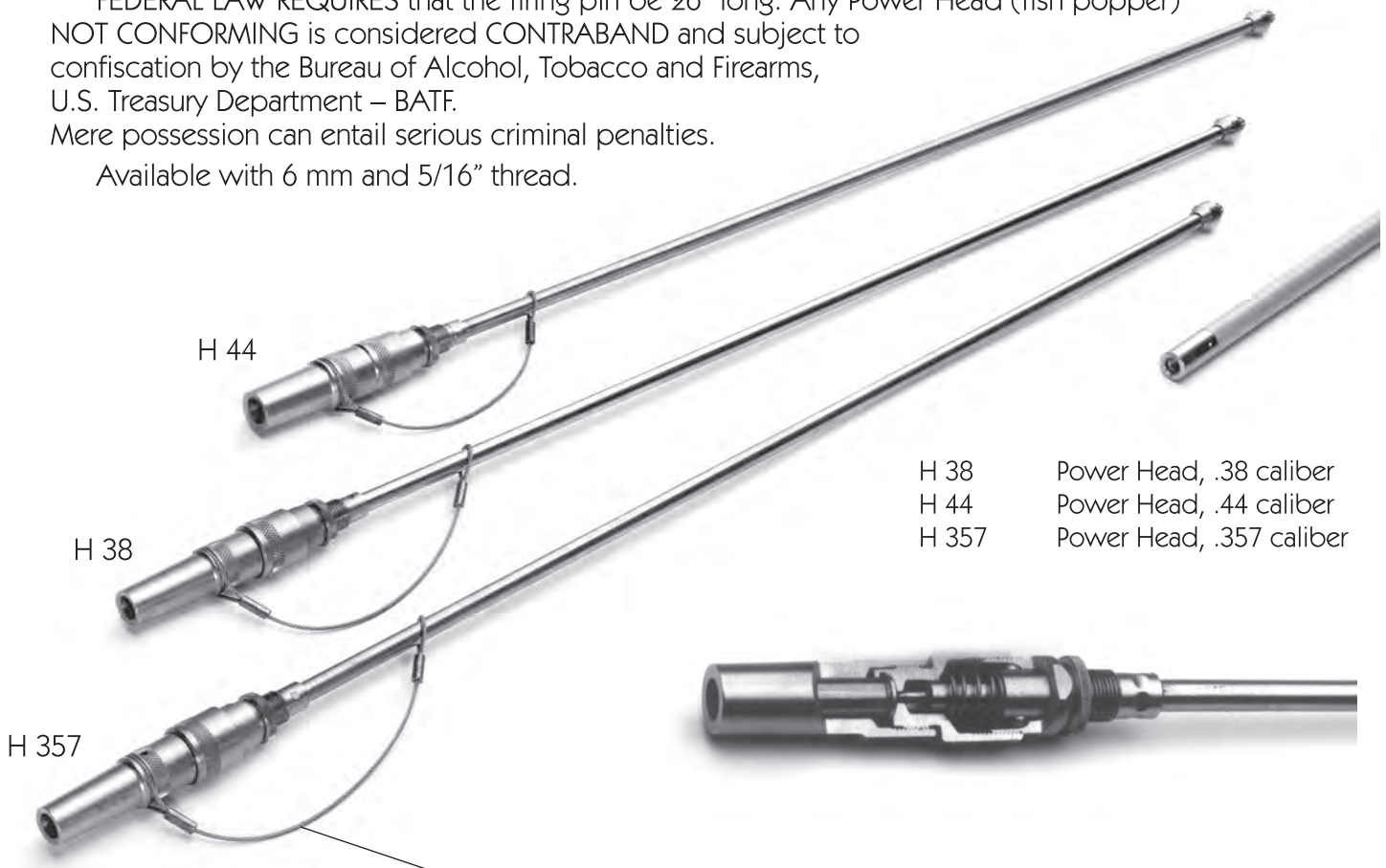

All A.B. Biller Power Heads come with a stainless steel cable attaching the barrel to the shaft to prevent the loss of the barrel while re-loading underwater.

OPERATION: The A.B. Biller Power Head has been designed for use and protection underwater, The device is not classified as a firearm but must be treated as such.

The knurled safety nut must be tightened against the Power Head body at all times and only loosened by three turns immediately before use. To load the Power Head the barrel must be unscrewed from the body and the barrel replaced finger tight. During loading and unloading special attention must be paid to insure that the safety nut is tight.

NOTE: It is recommended that the Power Head be used with BLANKS, since it is not the projectile, but the concussion of the explosion that kills the fish.

MAINTENANCE: The A.B. Biller Power Head is manufactured from high grade Stainless Steel and requires little maintenance.

After each use the Power Head should be rinsed with fresh water and lubricated with a very small amount of silicone.

Natural Rubber Tubing

This 100% natural rubber tubing is available in black or black coated amber in various sizes. See price list for details.

- 3/8" Diameter Pole Spear Tubing
- 1/2" Diameter Spear Gun Tubing
- 9/16" Diameter Spear Gun Tubing
- 5/8" Diameter Spear Gun Tubing



Gun Bands



9/16" OD Rubber

- R 313 13", for 24" guns
- R 314 14", for 32" guns
- R 316 16", for 36" guns
- R 318 18", for 42" guns
- R 320 20", for 48" guns
- R 322 22", for 54" guns
- R 324 24", for 60" guns

5/8" OD Rubber

- R 414 14", for 24" guns
- R 416 16", for 32" guns
- R 418 18", for 36" guns
- R 420 20", for 42" guns
- R 422 22", for 48" guns
- R 424 24", for 54" guns
- R 426 26", for 60" guns

- SC 48 Shock cord for 48" guns
- SC 54 Shock cord for 54" guns
- SC 60 Shock cord for 60" guns
- SCK 48-1000 Kevlar® Shock cord for 48" guns
- SCK 54-1000 Kevlar® Shock cord for 54" guns
- SCK 60-1000 Kevlar® Shock cord for 60" guns

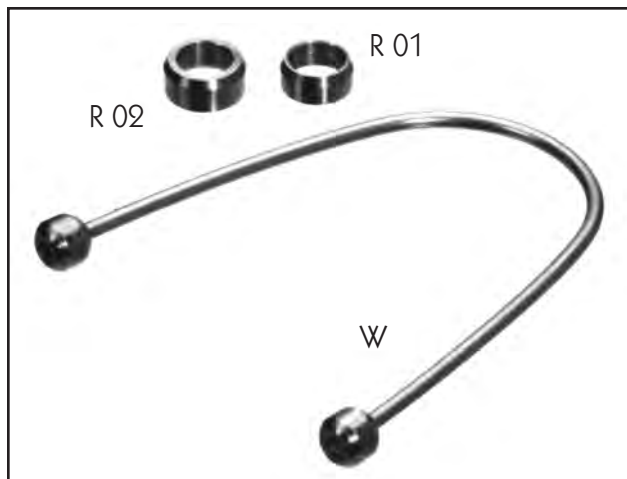

Wishbone made of hardened stainless steel. Machined stainless steel retainer rings.

- W Wishbone
- R 01 Retainer Ring for 1/2" and 9/16" Gun Band
- R 02 Retainer Ring for 5/8" Gun Band

Shock Cord Line

- SCL-NY 150 150 lbs. test, green Nylon line
- SCL-NY 300 300 lbs. test, black Nylon line
- SCL-KE 500 500 lbs. test, yellow waxed Kevlar® line
- SCL-KE 1000 1000 lbs. test, yellow waxed Kevlar® line



CP 12

Pliers/Crimps

Professional Crimping Pliers

CP 12 Crimping Pliers, Small

Copper Crimps

- CS 11 Single Cable Stop, 1/16" ID
- CS 12 Double Cable Stop, 1/16" ID
- CS 21 Single Cable Stop, 3/32" ID
- CS 22 Double Cable Stop, 3/32" ID
- CS 31 Single Cable Stop, 1/8" ID
- CS 32 Double Cable Stop, 1/8" ID

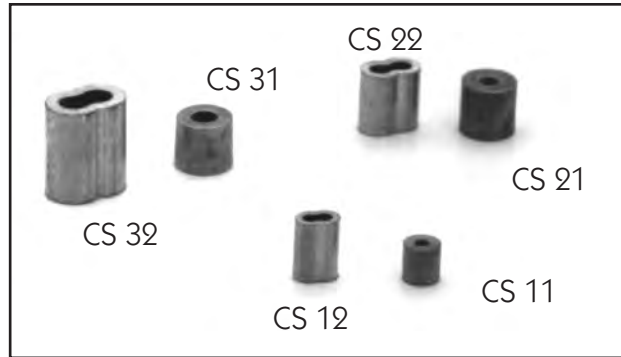

Cable

Stainless Steel Cable

- CST 10 Stainless Steel Cable, 1/16" ID
- CST 20 Stainless Steel Cable, 3/32" ID
- CST 30 Stainless Steel Cable, 1/8" ID





LTD T 60



LTD P 60



LTD M 60



LTD T 54



LTD P 54



LTD M 54



LTD T 48



LTD P 48



LTD M 48



LTD T 42



LTD P 42



LTD M 42



The A.B. Biller LTD



Model #	Shaft Length	Gun Length, Muzzle to Butt
LTD T 60 Teak	60"	60"
LTD P 60 Padauk	60"	60"
LTD M 60 Mahogany	60"	60"

Model #	Shaft Length	Gun Length, Muzzle to Butt
LTD T 54 Teak	54"	54"
LTD P 54 Padauk	54"	54"
LTD M 54 Mahogany	54"	54"

Model #	Shaft Length	Gun Length, Muzzle to Butt
LTD T 48 Teak	48"	50"
LTD P 48 Padauk	48"	50"
LTD M 48 Mahogany	48"	50"

Model #	Shaft Length	Gun Length, Muzzle to Butt
LTD T 42 Teak	42"	45"
LTD P 42 Padauk	42"	45"
LTD M 42 Mahogany	42"	45"

The A.B. Biller LTD is handcrafted from selected Mahogany, Padauk or Teak woods with the trigger mechanism and safety fitted directly into the gun barrel.

It is extremely difficult to obtain large quantities of truly straight barrels in these precious woods and therefore makes this speargun the limited edition it is named for.

The LTD is a fine example of A.B. Biller craftsmanship and quality.

The A.B. Biller LTD is available in 4 sizes.

The Biller Reel



The Biller Reel is a useful accessory to all A.B. Biller spearguns, wood or metal style. Made of rugged plastic, it features a line lock and ambidextrous mounting.

BR-W Reel with
Mounting Kit for
all Wood Guns

Stainless Spring Steel Spearpoints

Slimline Speartip

By using hardened stainless spring steel in the manufacture of these tips we have created what every spearfisherman is looking for – maximum strength and durability, reduced diameter, weight and drag as well as an easy and fast way to extract fish from the tip. The Slimline is available with Rockpoint, Tri-cut or 5/16" threaded point.

- 055-R Slimline Tip, Rockpoint
- 055-T Slimline Tip, Tri-cut
- 055-X Slimline Tip, Threaded
- 055-R-DE Slimline Tip, Rockpoint, Detachable Adapter
- 055-T-DE Slimline Tip, Tricut, Detachable Adapter

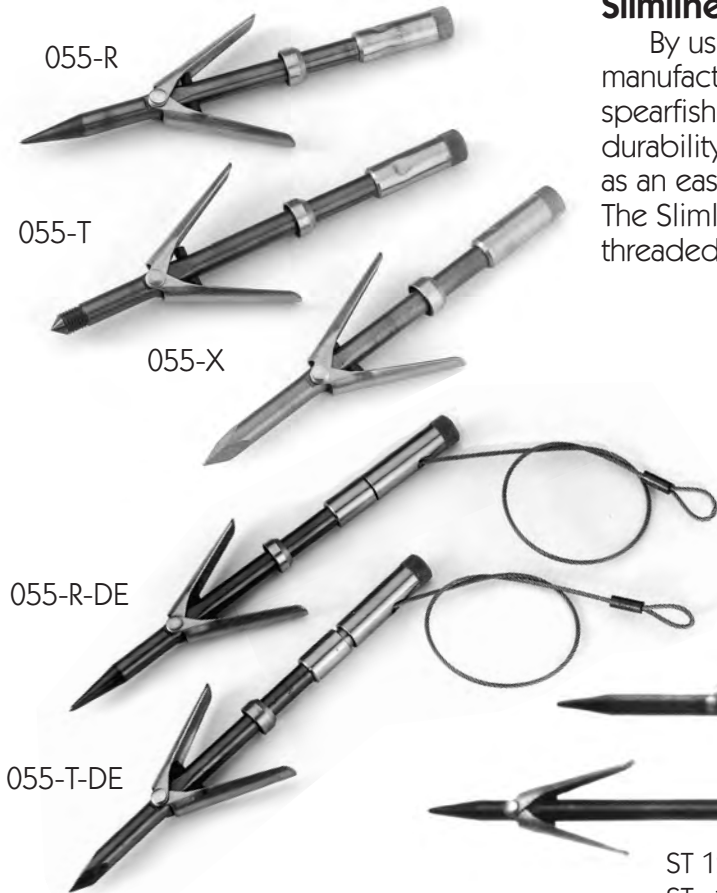

ST 12



ST 12-D

- ST 12 Shaft tip, 12", single barb, spring steel, 6mm
- ST 12-D Shaft tip, 12" double barb, spring steel, 6mm



ST 312

ST 612



PY 11

- ST 312 Shaft tip, Slip tip, 3" front piece, 6mm
- ST 612 Shaft tip, Slip tip, 6" front piece, 6mm
- PY 11 Paralyzer, spring steel, prongs, 6mm



The Australian Tip

A recreation of the old time favorite Australian Sea Hornet tip. Short, hardened stainless spring steel body with either Rockpoint or Tri-cut tip and stainless steel barbs extending past the tip body make this an extremely powerful, high impact speartip. Available with 6mm and 5/16" shaft thread.

- 051-R Australian Tip, Rockpoint, 6 mm
- 051-T Australian Tip, Tri-cut, 6 mm
- 053-R Australian Tip, Rockpoint, 5/16" (not pictured)
- 053-T Australian Tip, Tri-cut, 5/16" (not pictured)



051-R

051-T

Stainless Spring Steel Slip Tips

Hardened stainless spring steel tips with Rockpoint or Tri-cut, heavy cable (1/16" or 3/32") with loops to connect to reels or shock cords.

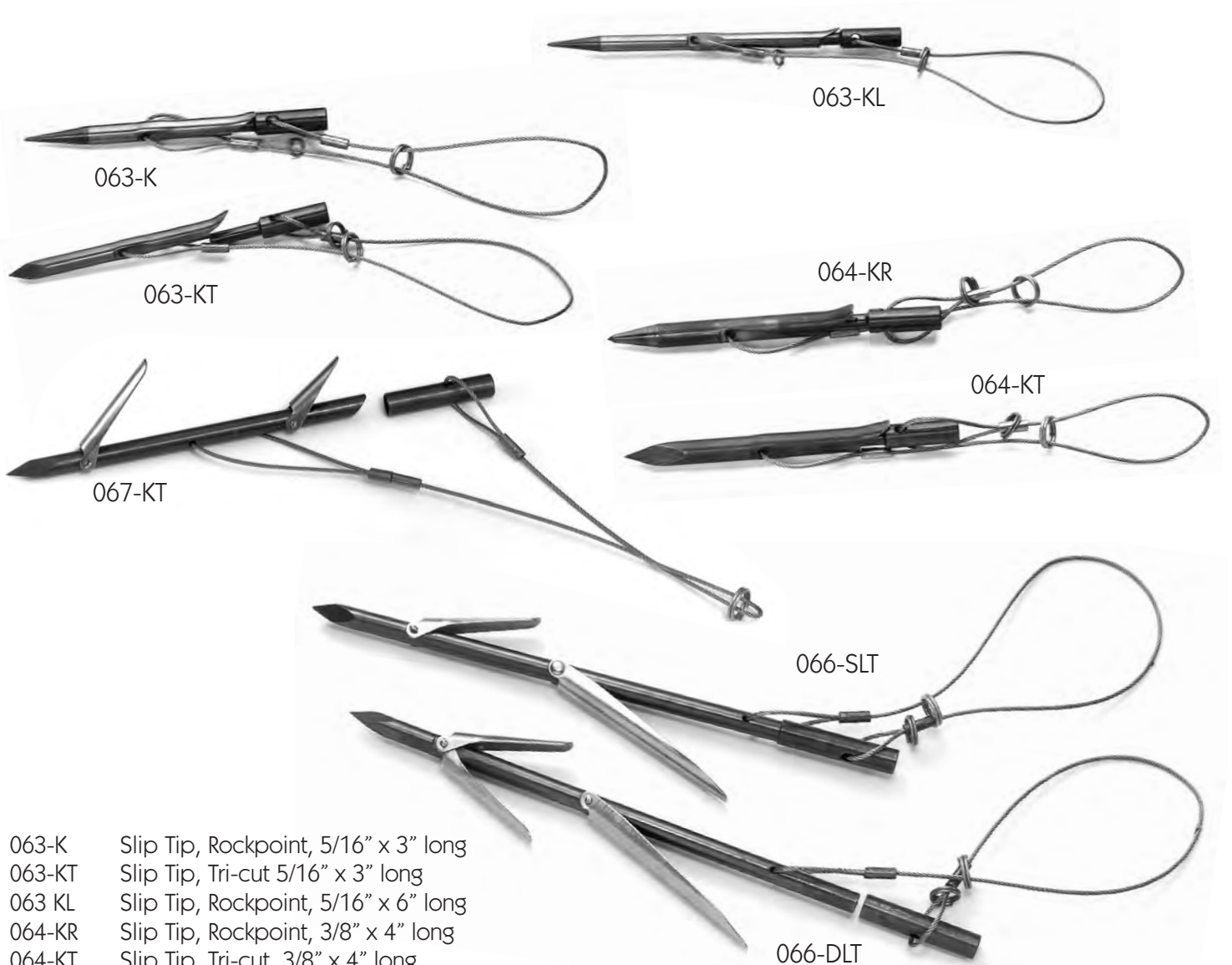

- 063-K Slip Tip, Rockpoint, 5/16" x 3" long
- 063-KT Slip Tip, Tri-cut 5/16" x 3" long
- 063-KL Slip Tip, Rockpoint, 5/16" x 6" long
- 064-KR Slip Tip, Rockpoint, 3/8" x 4" long
- 064-KT Slip Tip, Tri-cut, 3/8" x 4" long
- 066-SLT Multi-barb, Slip Tip, 5/16" x 10" long
- 066-DLT Multi-barb, Slip Tip, 5/16" x 10" long
- 067-KT Slip Tip, Tri-cut, 2 barbs

Fish Stringer



TFS

An advanced, yet simple to use fish keeper that renders cumbersome bags and metal loops obsolete. The hardened, stainless spring steel pin is slightly curved at its sharpened tip for easy penetration of the fish while the 350 lb. test cord with removable stainless steel ring will securely hold your catch.

TFS Tournament Fish Stringer

Stainless Steel Spearpoints

A.B. Biller Spearpoints are crafted from high grade stainless steel with attention to detail and versatility. Shown here are the individual components that together make up a variety of more than 60 spearpoints. All parts are interchangeable and allow easy assembly of the exact spearpoint best suited to any situation.



TIPS (with Safety Cap)

- R Rockpoint
- T Tri-cut
- TS Tri-cut Special
- RH Rockpoint hardened
- TH Tri-cut hardened

SHAFTS (with Barbs and Retainer)

- S Short barbed
- L Long barbed

SHAFTS (with Barbs and Retainer, Fixed Swivel)

- S-FSW Short Barbs
- L-FSW Long Barbs

ADAPTERS (6 mm)

- ST Standard
- SW Swivel
- HI Hingeable
- DE Detachable

THREAD ADAPTERS

- 071 6 mm male to 12-24 female
- 072 6 mm male to 7mm female
- 073 6 mm male to 5/16 female
- 074 6 mm female to 5/16 female (not pictured)

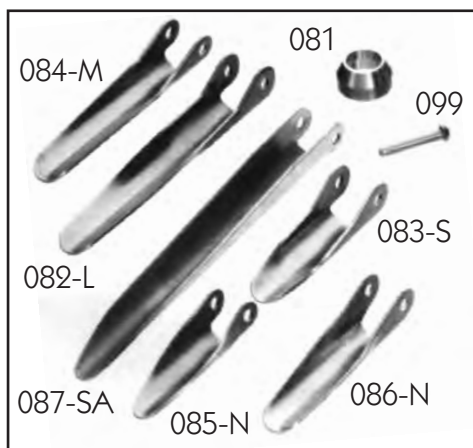

For details on all stainless steel barbs, pins and retainer rings. please see price list.



A.B. Biller Economy stainless steel Spear Point.

061-S Single barb

Here are just a few spear points assembled as needed from the components on the opposite page.



R-L-ST
TS-L-SW
R-L-HI
R-S-ST
TS-L-FSW

Rockpoint, Long barb, Standard
Tri-cut Special, Long barb, Swivel
Rockpoint, Long barb Hingeable
Rockpoint, Short barb, Standard
Tri-cut Special, Long barb, Fixed Swivel

T-S-SW
T-S-HI
R-S-FSW
R-L-DE
T-S-DE

Tri-cut, Short barb, Swivel
Tri-cut, Short barb, Hingeable
Rockpoint, Short barb, Fixed Swivel
Rockpoint, Long barb, Detachable
Tri-cut, Short barb, Detachable

Travel Spears & Accessories

A.B. Biller Travel Spears are manufactured from solid 9/16" fiberglass and assembled with stainless steel fittings.

Compact and versatile. A.B. Biller provides two systems:

- Three 24" sections for a 6' Pole Spear
- Three 18" sections for a 4-1/2' Pole Spear

Either system comes complete with connectors, sling eye and sling in a sturdy carrying bag, together with the tip of your choice.

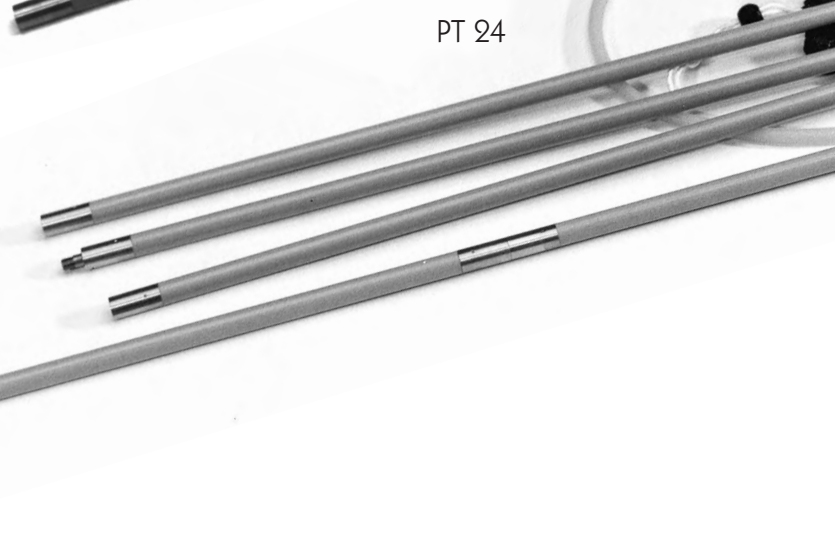

PT 24-PK 312	6' Travel Spear, three 24" sections, Slip Tip
PT 24-PY 21	6' Travel Spear, three 24" sections, Paralyzer
PT 24-PT 12	6' Travel Spear, three 24" sections, PT 12
PT 24-PAL	6' Travel Spear, three 24" sections, PAL
PT 18-PK 312	4-1/2' Travel Spear, three 18" sections, Slip Tip
PT 18-PY 21	4-1/2' Travel Spear, three 18" sections, Paralyzer
PT 18-PT 12	4-1/2' Travel Spear, three 18" sections, PT 12
PT 18-PAL	4-1/2' Travel Spear, three 18" sections, PAL
PT 12	Pole Tip, single barb, stainless spring steel, 12"
PAL	Pole Adapter, stainless spring steel, 6" long, 5/16" to 6mm
PE	Pole Sling Eye, stainless steel
PC	Pole Connector, stainless steel



PK 312



PK 612



PY 22



PY 21

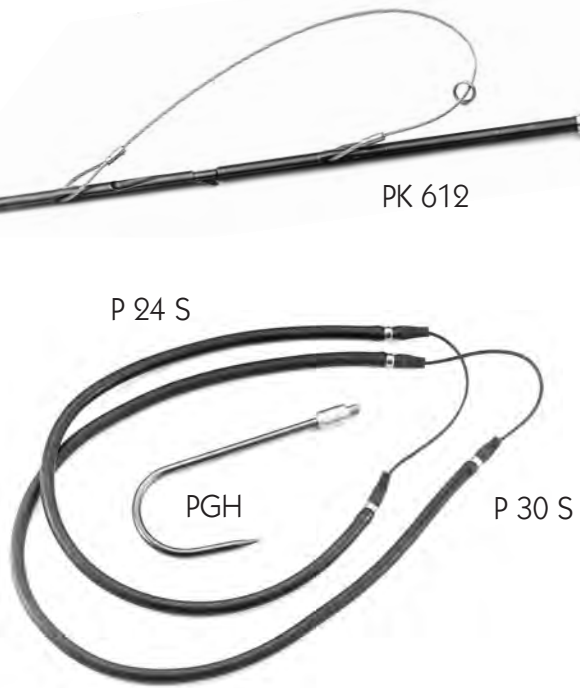

P 24 S



P 30 S

PGH

- PK 312 Slip Tip, stainless spring steel, 12", 3" tip
- PK 612 Slip Tip, stainless spring steel, 12" 6" tip
- PY 11 Paralyzer, stainless spring steel prongs, 6mm (see page 18)
- PY 21 Paralyzer, stainless spring steel prongs, 5/16"
- PY 22 Paralyzer, stainless spring steel prongs, 5/16", one prong barbed
- PGH Gaff Hook, stainless spring steel
- P 24 S 24" Pole Sling
- P 30 S 30" Pole Sling
- PS 18 18" Pole Section
- PS 24 24" Pole Section
- PB 18 Bag for 18" sections
- PB 24 Bag for 24" sections

All above products may be ordered individually to create a wide range of pole spear and tip combinations or to expand existing systems, see pages 20 through 23.

Pole Spears

P 6-PK 312 6' Pole Spear, Sling, Slip Tip
 P6-PY 21 6' Pole Spear, Sling, Paralyzer
 P6-PT 12 6' Pole Spear, Sling, PT 12
 P6-PAL 6' Pole Spear, Sling, PAL
 P 6 6' Pole only

P 5-PK 312 5' Pole Spear, Sling, Slip Tip
 P 5-PY 21 5' Pole Spear, Sling, Paralyzer
 P 5-PT 12 5' Pole Spear, Sling, PT 12
 P 5-PAL 5' Pole Spear, Sling, PAL
 P 5 5' Pole only
 (5' Pole combinations are not pictured.)

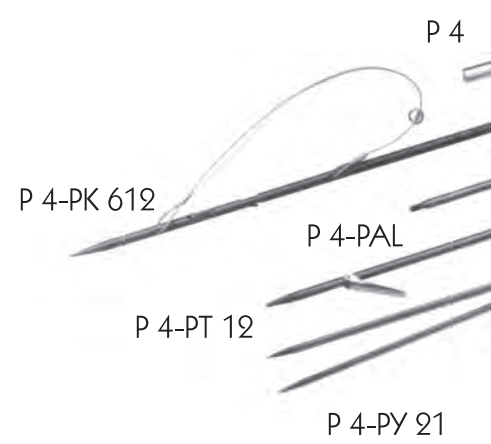
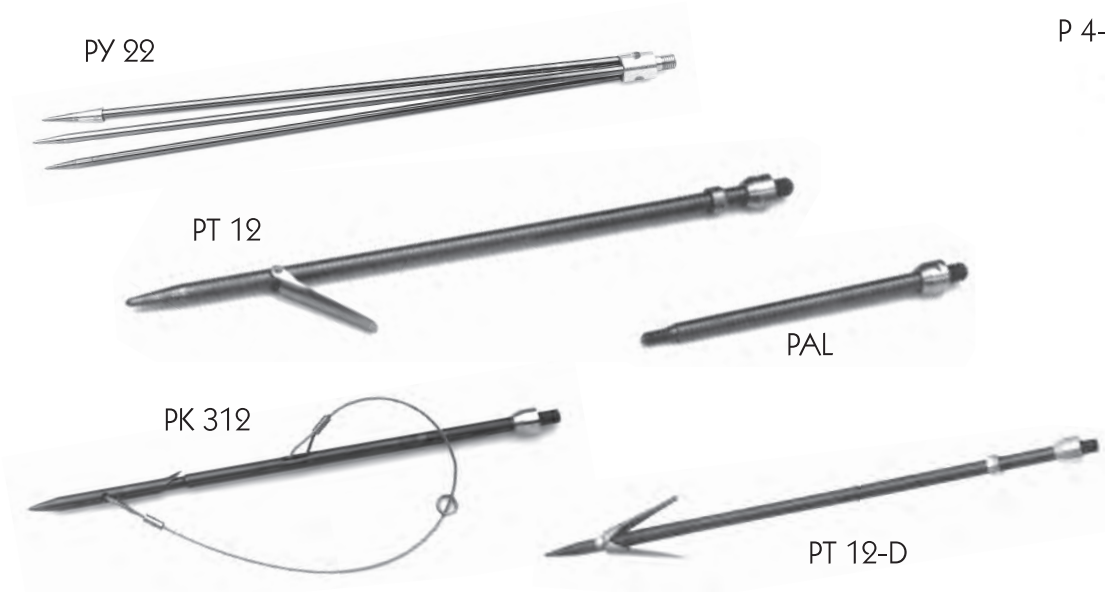
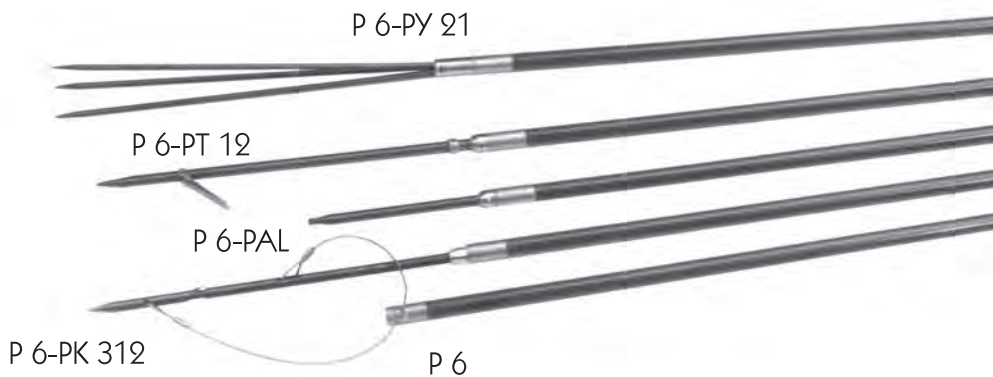

PK 312 Slip Tip
 PY 22 Paralyzer, stainless spring steel, barbed
 PT 12 Pole Tip, single barb, stainless spring steel, 12"
 PT 12-D Pole Tip, double barb, stainless spring steel, 12"
 PAL Pole Adapter long, stainless spring steel, 6mm, 5/16"

P 4-PK 612 4' Pole Spear, Sling, Slip Tip, long
 P 4-PY 21 4' Pole Spear, Sling, Paralyzer
 P 4-PT 12 4' Pole Spear, Sling, PT 12
 P 4-PAL 4' Pole Spear, Sling, PAL
 P 4 4' Pole only

A.B. Biller Pole Spears are manufactured from solid 9'16" fiberglass and assembled with stainless steel fittings. The slings are 100% natural rubber tubing.

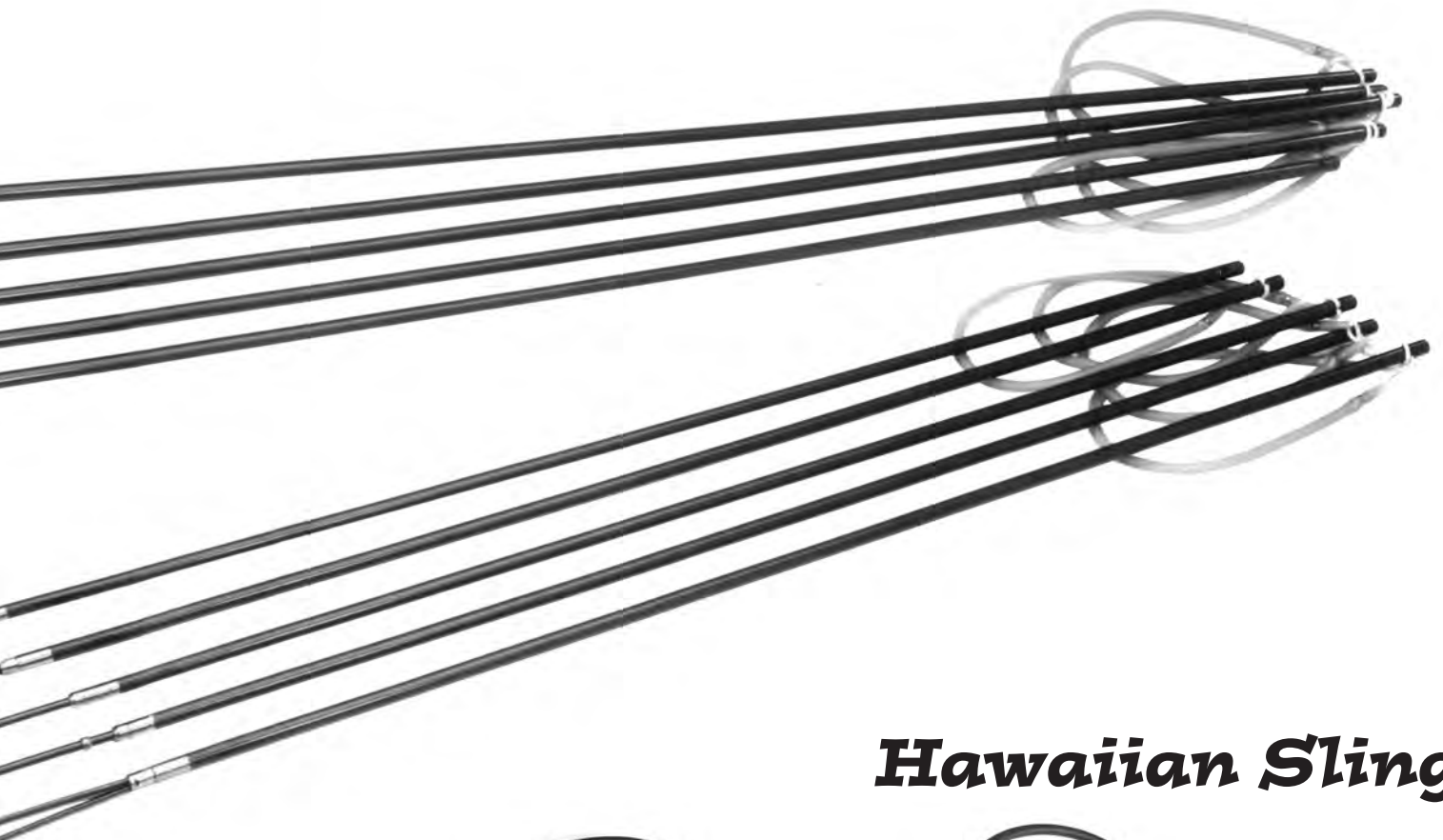

Hawaiian Sling



- HMG Hawaiian Sling, mahogany, with grip
- HTG Hawaiian Sling, teak, with grip
- HM Hawaiian Sling, mahogany
- HT Hawaiian Sling, teak
- SH 60-1/4 Springsteel shaft, 60" x 1/4"

Hand crafted from high grade Mahogany and Teak, these units have no equal in beauty of design, quality of materials and functional reliability.

For a detailed description of all available Hawaiian Sling shafts, please consult your A.B. Biller price list.

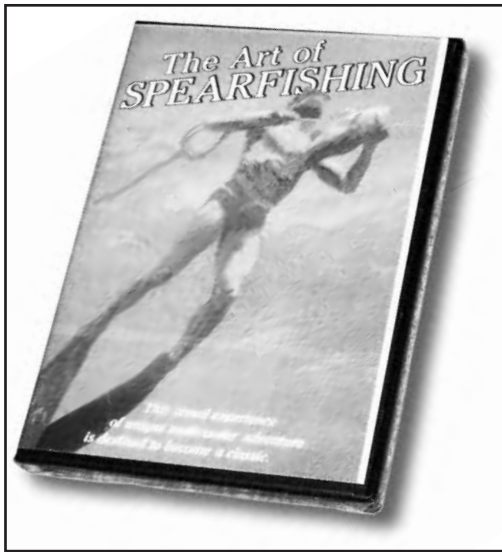

Spearfishing DVD

The Art of Spearfishing, a 30-minute DVD features champion spearfisherman and women in beautiful and exciting underwater action footage. This educational DVD will capture the attention of all sport divers – students & veterans alike. It provides insight on the history of underwater hunting, and an overview of equipment and technology as well as addressing the ecological impact of spear fishing.

DVD1 Spearfishing DVD

Spearfishing Handbook

Spearfishing and Underwater Hunting Handbook provides beginner through advanced “how to” information on spearfishing technique, equipment selection, use, maintenance, safety, and etiquette. 128 pages with over 90 photos and illustrations, revised edition.

BOOK1 Spearfishing Handbook

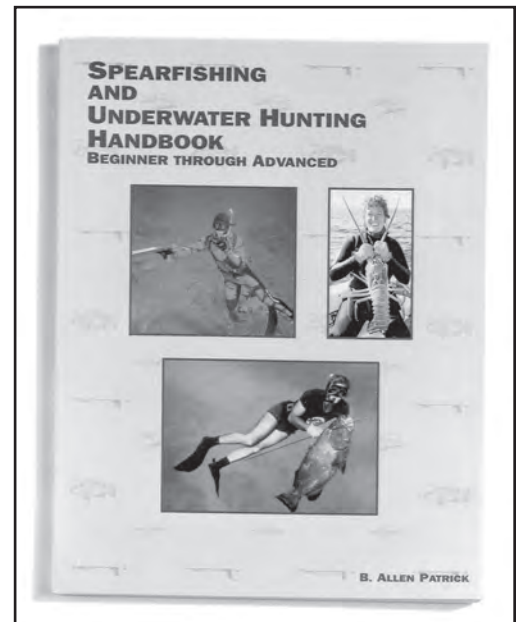

Plated Spearpoints

Nickel plated hardened steel spear points with stainless steel barbs and pin.

001-S Single Barb Rockpoint

002-D Double Barb Rockpoint

001-D Double Barb Rockpoint, small

003-D Double Barb Rockpoint with rubber spring



001-S

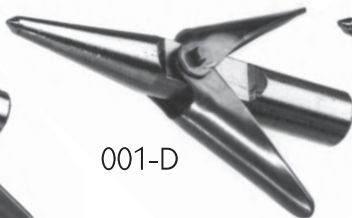

001-D



002-D

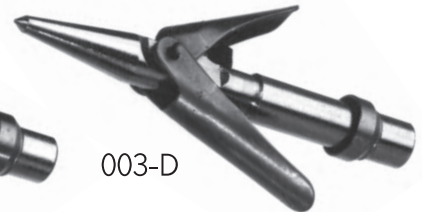

003-D

Display Rack For Spearguns



The A.B. Biller tradition of premier quality products is reflected in this attractive and space saving display unit.

Specially designed for A.B. Biller Spearguns, these display racks will free some wall or floor space, while increasing your sales through pleasing visual merchandising. The gun rack measures 17" wide, 14" deep, and 29" high.

FDR 8 Floor display rack, 8 guns

The gun rack will be shipped unassembled. All instructions for easy assembly and all necessary hardware will be included.

the
AB Biller
company

Polo Shirts



Be one of the team with this high quality 100% combed cotton heavyweight pique knit polo shirt. It has side vents, a 2 1/2" drop tail and is available in a variety of colors and sizes.

The A.B. Biller logo and speargun are embroidered on the left front side.

- Polo 1 Polo shirt, White
- Polo 2 Polo shirt, Royal Blue
- Polo 3 Polo shirt, Forest Green
- Polo 4 Polo shirt, Pure Gold
- Polo 5 Polo shirt, Bright Red

Please specify size: Medium, Large, X-Large or XX-Large.



Cap

100% cotton, adjustable cap. Available in Khaki embroidered with the A.B. Biller logo and speargun.

- Cap 1 Khaki

Carrying Bag



The carrying bag is available in three sizes to accommodate any A.B. Biller speargun.

Keep your investment looking new with our speargun carrying bag. It will hold 2 guns, your fins and mask and has a storage pocket for small items.

- GB 60 Bag for guns, 54" and 60"
- GB 48 Bag for guns, 42" and 48"
- GB 36 Bag for guns, 36" and smaller

A.B.Biller Guns...
Mandatory!
A.B.Biller T-shirts...
Optional?



**A.B.Biller
T-shirts
now at your
select
Pro-Dive
Stores**



the
ABBill
company

630.529.2729
www.abbiller.com



**Post Office Box 316
Bloomington, IL 60108
(630) 529-2729
FAX (630) 529-4473
www.ABBILLER.com**

WARRANTY

The A.B. Biller Company provides a limited lifetime warranty to the original owner of all products manufactured by the A.B. Biller Company. We will repair or replace to the customer any product to be found to be defective in material or workmanship. However, this warranty does not cover normal wear or damages arising from environmental influences, misuse or careless treatment of the product.